

Features

- Epitaxial Planar Die Construction
- Ultra-Small Leadless Surface Mount Package
- Ideally Suited for Automated Assembly Processes
- Lead Free By Design/RoHS Compliant (Note 1)
- "Green" Device (Note 2)
- Qualified to AEC-Q101 Standards for High Reliability

Mechanical Data

- Case: DFN1006-3
- Case Material: Molded Plastic, "Green" Molding Compound. UL Flammability Classification Rating 94V-0
- Moisture Sensitivity: Level 1 per J-STD-020D
- Terminal Connections: Collector Dot (See Diagram and Marking Information)
- Terminals: Finish — NiPdAu over Copper leadframe. Solderable per MIL-STD-202, Method 208
- Marking Code P2, Dot denotes Collector Side
- Ordering Information: See Page 4
- Weight: 0.0009 grams (approximate)

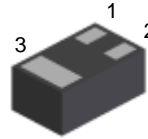

Bottom View

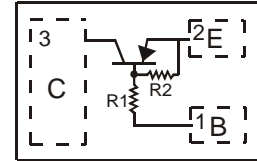

Top View

DFN1006-3

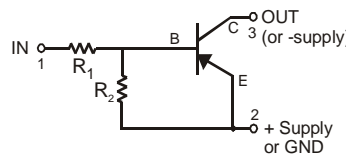

Schematic and Pin Configuration

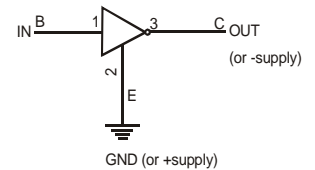

Equivalent Inverter Circuit

Component P/N	R1(NOM)	R2(NOM)
DDTA144ELP	47K	47K

Maximum Ratings @T_A = 25°C unless otherwise specified

Characteristic	Symbol	Value	Unit
Supply Voltage	V _{CC}	-50	V
Input Voltage	V _{IN}	+10 to -40	V
Output Current (I _o)	I _{C(max)}	-100	mA
Power Dissipation (Note 3)	P _D	250	mW
Power Deration above 25°C	P _{der}	2	mW/°C

Thermal Characteristics

Characteristic	Symbol	Value	Unit
Thermal Resistance, Junction to Ambient Air (Note 3) (Equivalent to one heated junction of PNP)	R _{θJA}	500	°C/W
Operating and Storage Temperature Range	T _j , T _{STG}	-55 to +150	°C

- Notes:
1. No purposefully added lead.
 2. Diodes Inc.'s "Green" policy can be found on our website at http://www.diodes.com/products/lead_free/index.php.
 3. Device mounted on FR-4 PCB, 1" x 0.85" x 0.062"; pad layout as shown on page 5 or Diodes Inc. suggested pad layout document AP02001, which can be found on our website at <http://www.diodes.com/datasheets/ap02001.pdf>.

Electrical Characteristics @T_A = 25°C unless otherwise specified

Characteristic	Symbol	Min	Typ	Max	Unit	Test Condition
Off Characteristics (Note 4)						
Collector-Base Breakdown Voltage	V _{(BR)CBO}	-50	—	—	V	I _C = -10μA, I _E = 0
Collector-Emitter Breakdown Voltage	V _{(BR)CEO}	-50	—	—	V	I _C = -1.0mA, I _B = 0
Emitter-Base Breakdown Voltage*	V _{(BR)EBO}	-4.5	—	—	V	I _E = -50μA, I _C = 0
Collector Cutoff Current*	I _{CEX}	—	—	-0.5	μA	V _{CE} = -50V, V _{EB(OFF)} = 3.0V
Base Cutoff Current (I _{BEX})	I _{BL}	—	—	-0.5	μA	V _{CE} = -50V, V _{EB(OFF)} = 3.0V
Collector-Base Cut Off Current	I _{CBO}	—	—	-0.5	μA	V _{CB} = -50V, I _E = 0
Collector-Emitter Cut Off Current, I _{O(OFF)}	I _{CEO}	—	—	-0.5	μA	V _{CE} = -50V, I _B = 0
Emitter-Base Cut Off Current	I _{EBO}	—	—	-0.5	mA	V _{EB} = 4V, I _C = 0
Input Off Voltage	V _{I(OFF)}	—	—	-0.3	V	V _{CC} = -5V, I _O = -100uA
On Characteristics (Note 4)						
Base-Emitter Turn-On Voltage*	V _{BE(ON)}	—	—	-0.69	V	V _{CE} = -5V, I _C = -2mA
		—	—	-0.78	V	V _{CE} = -5V, I _C = -10mA
Base-Emitter Saturation Voltage*	V _{BE(SAT)}	—	—	-0.88	V	I _C = -10mA, I _B = -1mA, V _{CE} = -5V
		—	—	-0.98	V	I _C = -50mA, I _B = -5mA, V _{CE} = -5V
Input-On Voltage	V _{I(ON)}	-3	—	—	V	V _O = -0.3V, I _O = -20mA
Input Current	I _I	—	—	-7.2	mA	V _I = -5V
DC Current Gain	h _{FE}	90	—	—	—	V _{CE} = -5V, I _C = -2mA
		120	—	—	—	V _{CE} = -5V, I _C = -5mA
		150	—	—	—	V _{CE} = -5V, I _C = -10mA
		100	—	—	—	V _{CE} = -5V, I _C = -100mA
		180	—	—	—	V _{CE} = -5V, I _C = -200mA
		250	—	—	—	V _{CE} = -5V, I _C = -300mA
Collector-Emitter Saturation Voltage*	V _{CE(SAT)}	—	—	-0.15	V	I _B = -1mA, I _C = -10mA
		—	—	-0.85	V	I _B = -5mA, I _C = -50mA
Output On Voltage (Same as V _{CE(SAT)})	V _{O(ON)}	—	—	-0.3	V	I _I = -0.5mA, I _O = -50mA
Input Resistance	R ₁	32.9	47	61.1	KΩ	—
Resistance Ratio	(R ₂ /R ₁)	0.8	1.0	1.2	—	—
Small Signal Characteristics						
Current Gain-Bandwidth Product	f _T	—	250	—	MHz	V _{CE} = -10V, I _E = -5mA, f = 100 MHz

* Guaranteed by design.

Notes: 4. Short duration pulse test used to minimize self-heating effect.
Pulse Test: Pulse width t_p < 300 uS, Duty Cycle, d < 2%.

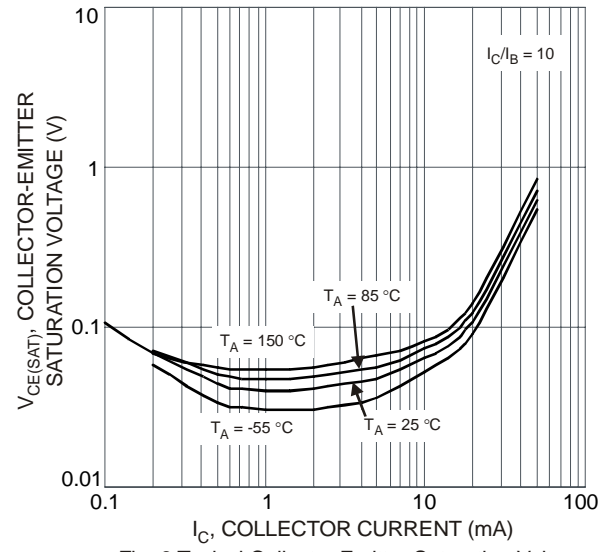
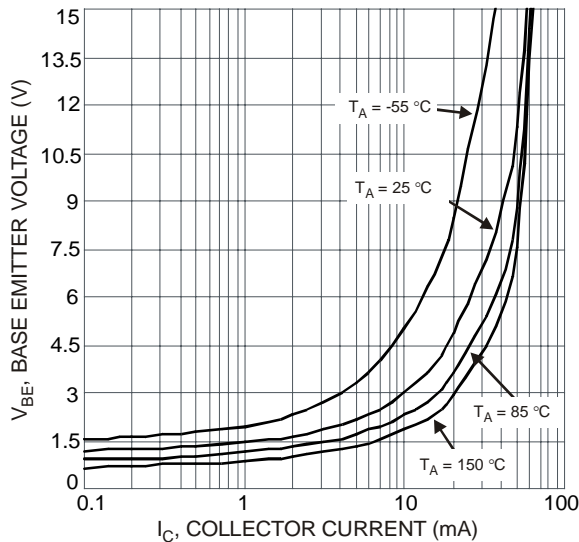
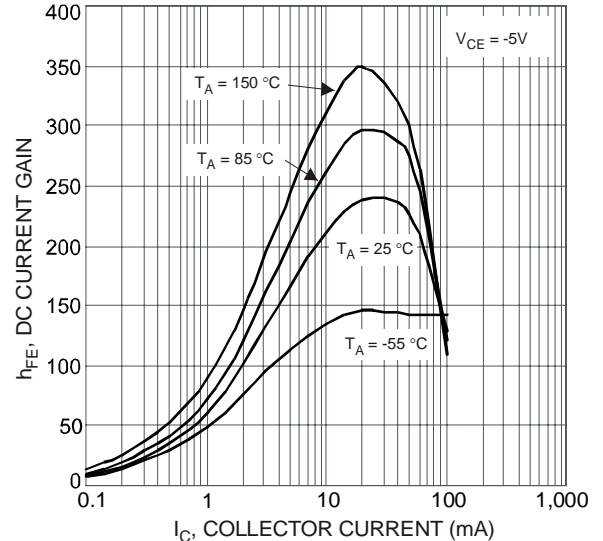
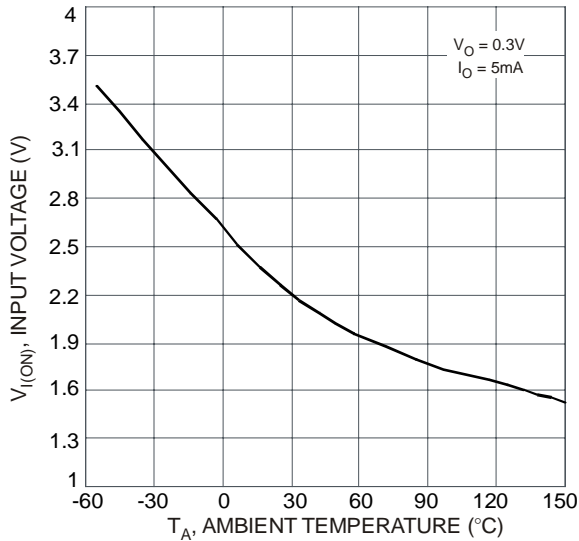
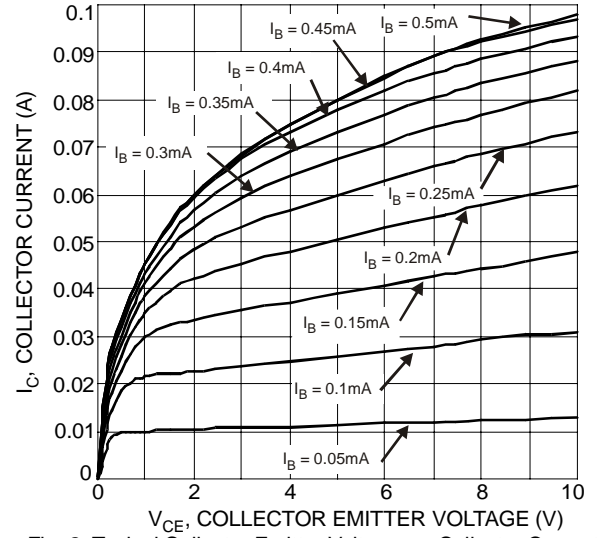
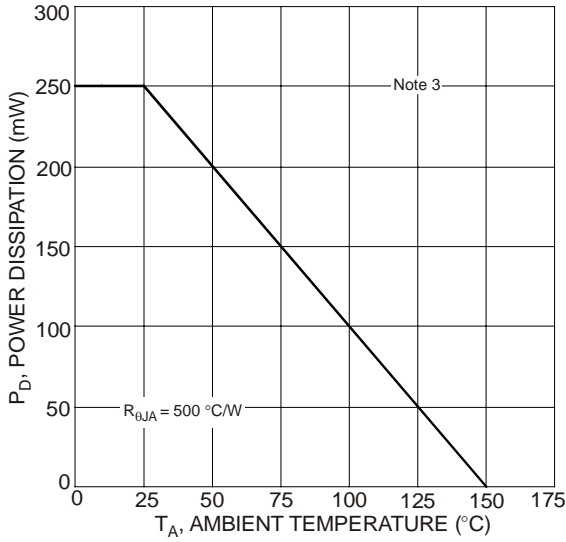

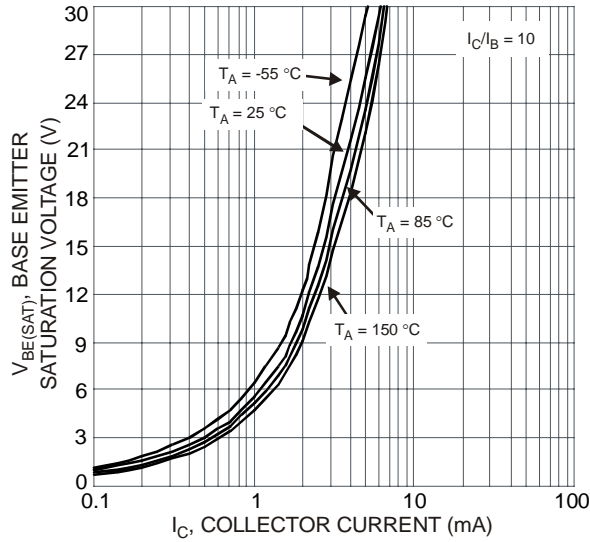

Fig. 7 Typical Base Emitter Saturation Voltage vs. Collector Current

Ordering Information (Note 6)

Device	Packaging	Shipping
DDTA144ELP-7	DFN1006-3	3000/Tape & Reel

Notes: 6. For packaging details, please see page 5 or go to our website at <http://www.diodes.com/ap2007.pdf>.

Marking Information

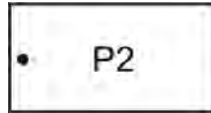

P2 = Product Type Marking Code
Dot Denotes Collector, Pin 3

Mechanical Details

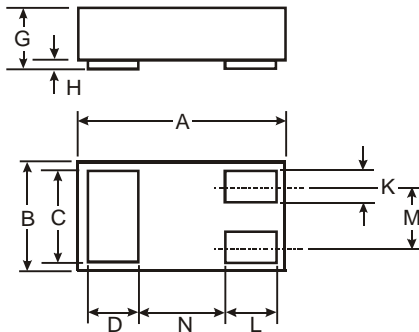

DFN1006-3			
Dim	Min	Max	Typ
A	0.95	1.075	1.00
B	0.55	0.675	0.60
C	0.45	0.55	0.50
D	0.20	0.30	0.25
G	0.47	0.53	0.50
H	0	0.05	0.03
K	0.10	0.20	0.15
L	0.20	0.30	0.25
M	—	—	0.35
N	—	—	0.40
All Dimensions in mm			

Suggested Pad Layout

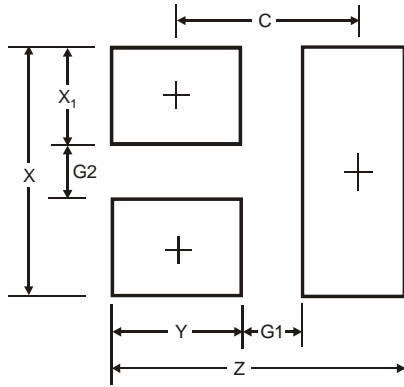

Dimensions	Value (in mm)
Z	1.1
G1	0.3
G2	0.2
X	0.7
X1	0.25
Y	0.4
C	0.7

IMPORTANT NOTICE

Diodes Incorporated and its subsidiaries reserve the right to make modifications, enhancements, improvements, corrections or other changes without further notice to any product herein. Diodes Incorporated does not assume any liability arising out of the application or use of any product described herein; neither does it convey any license under its patent rights, nor the rights of others. The user of products in such applications shall assume all risks of such use and will agree to hold Diodes Incorporated and all the companies whose products are represented on our website, harmless against all damages.

LIFE SUPPORT

Diodes Incorporated products are not authorized for use as critical components in life support devices or systems without the expressed written approval of the President of Diodes Incorporated.